

# HEAVY-DUTY WORKSTATIONS

Workbench 3000 Series

### UPPER ADD ONS *(requires lightframe)*

LED Light	Paper Tray
Fan Kit	Parts Bin
Pegboard Kit	Small PC Hanger
Whiteboard Kit	Monitor Mount
Whiteboard/Pegboard Kit	Basic Monitor Arm
Tool Trolley available with Tool Balancer	Ergo Arm Tray
Roll Holder	Single Monitor
Upper Flow Rack Shelf	Dual Monitor
Tool Bin Bracket	Monitor/Keyboard
Upper Shelf (12" or 24")	Keyboard Only
	Tool Bins

### OTHER ADD ONS *(lightframe not required)*

Drawer Kits Large, Small or Combo	PC Tower Hanger
Lower Shelf	Power Strip
Lower Pegboard	

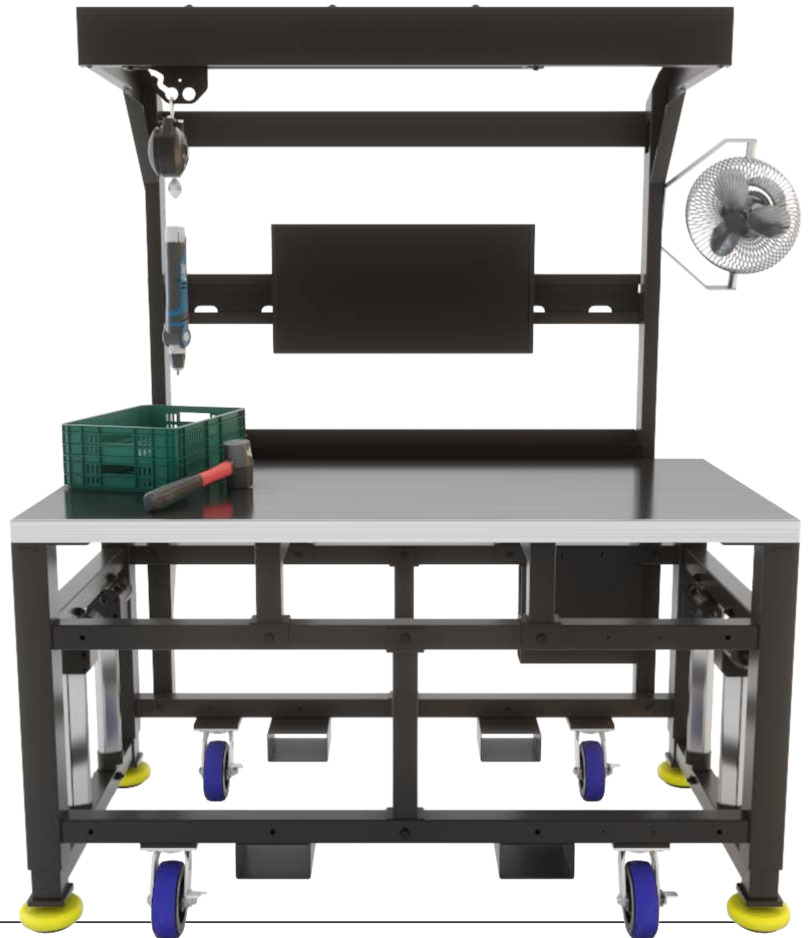

### LIFT CAPACITY

3000 lbs

### STANDARD SIZES



Starting height: 32.5" | 36.5"  
Widths: 48" | 60" | 72"  
Depths: 30" | 36"

### ADJUSTMENT



12" or 16" vertical adjustment  
at .25" per second  
Actuators provide heavy-duty lift power  
Available with electric  
height-adjustment only  
Simple or programmable control switch

### STANDARD COLORS

VOC-free powder coating

	RAL 9003 - Signal White
	RAL 7037 - Dusty Grey
	OB07 - Matte Black

### STANDARD SURFACES

	Butcher Block
	HPL Black
	HPL White

electrostatic discharge (ESD) options

### STABILITY

Rigid cold-rolled steel construction  
Anti-vibration mounts  
with 6" retractable casters

### CUSTOMIZATION

Custom Sizes, Color  
and Branding available

*Shown with Lightframe, Tool Trolley + Balancer,  
Monitor Mount, Fan Kit, and Parts Bin*

## TECHNICAL

# HEAVY-DUTY WORKSTATIONS

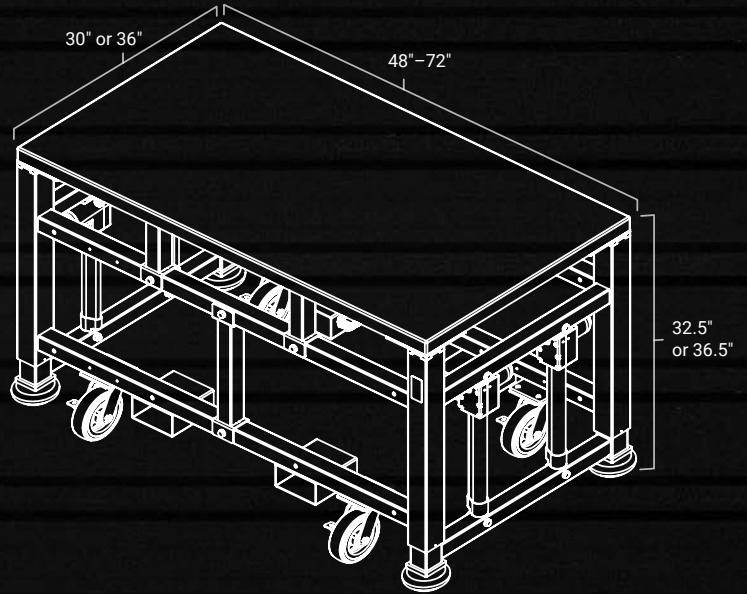

### ANCHORED MOUNTS

4 in x 5.5 in Tear-Drop Shape  
 9/16 in Anchor Hole  
 5/8-11 Thread  
 7.5° Range Of Motion  
 Ball-and-Socket Swivel  
 8 in Stud Length  
 6000 lbs Capacity Each

### MIGHTY MOUNTS

Anti-Vibration, Leveling  
 5 in Diameter  
 5/8-11 Thread  
 8Hz Natural Frequency  
 2000 lbs Capacity Each

### CASTERS

6 in Swivel With Brake  
*(Rigid Casters Optional)*  
 Polyurethane -  
 Shore A 80 Durometer  
 1100 lbs Capacity Each

### ACTUATORS

Custom Designed 12 in or 16 in  
 Linear Actuators (Bolt-On)  
 IP66 Rated  
 Speed - 6.3 mm/Second  
 (1/4 in/Second) @ Zero Load  
 3.5 mm/Second  
 (9/64 in/Second) @ Max Load  
 3000 lbs Maximum Weight Capacity  
 (Evenly Distributed)  
 Mechanical Brake Spindle Nut For  
 Redundant Protection



No Lightframe

With Lightframe

## ELECTRICAL SPECS

Power Supply 120VAC 10% / 60Hz  
 Standby Power Consumption < 0.3 Watts  
 Operating Temperature 0-35° C  
 Protection Class IP20  
 Maximum Power Output 216VA/24V

### 4 Actuator System with 2 Control Boxes:

Maximum Lift Capacity 3000LBS (1587kg / 15,568N)  
 Adj. Range 12IN  
 Maximum Input Current 5A  
 Maximum Duty Cycle 10% (2 MIN ON / 18 MIN OFF)

*Specifications may vary based on system configuration and workload.*